

*Pursuit of Excellence*



Since 1989

# KICKLESS CABLE

## (LOW REACTANCE CABLE)

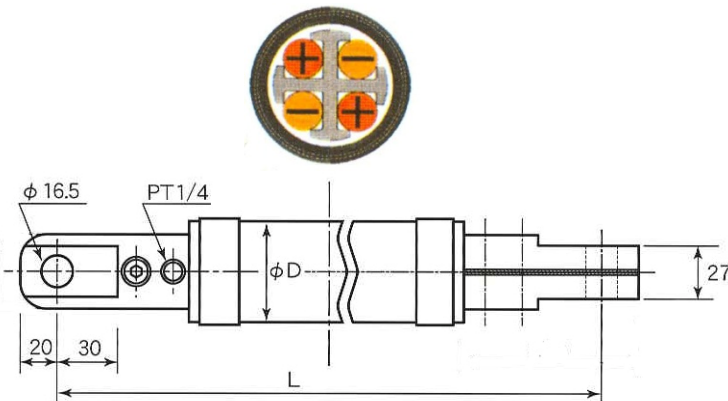

Item	Specification								
	300 MCM (2x150 Sq.mm.)			400 MCM (2x200 Sq.mm.)			500 MCM (2x250 Sq.mm.)		
	2.0 m	2.4 m	3.0 m	2.0 m	2.4 m	3.0 m	2.0 m	2.4 m	3.0 m
<b>Resistance (<math>\mu\Omega</math>) *</b>	460	550	680	330	400	495	265	320	400
<b>Reactance (<math>\mu\Omega</math>) **</b>	68	81	90	45	57	71	33	44	57
<b>Impedance (<math>\mu\Omega</math>) **</b>	465±10	556±10	686±10	333±15	404±15	500±15	267±20	323±20	404±20
<b>Power Factor</b>	≈0.99								
<b>Breakdown Pressure</b>	8 kg/cm <sup>2</sup>								
<b>Cooling Water Rate</b>	6 Liter/min								
<b>Outer Diameter (mm)</b>	52 mm			56 mm			63 mm		

\* By measuring under JIS C9318-1976 at 25°C

\*\* By calculating under ISO 8205-1:2002 at 50 Hz

### Feature

- ✓ Unique “X-shape” separator maintains strand positioning and equally distributed cooling water flow
- ✓ State-of-the-art 4-wire design to minimize current loss, reduced CO<sub>2</sub> emission
- ✓ Electrolytic tough pitch annealed, bare copper wire, 28 AWG, herringbone rope construction for greater flexibility and reduced wear point
- ✓ High temperature internal restraining collars to minimize stress in the bending area
- ✓ Lowest reactance of the class to engage lower primary power demand
- ✓ No noticeable pulsation due to low magnetic kicking
- ✓ Improved flexibility, smaller bend radii comparing to previous model
- ✓ Reduced operator fatigue, higher productivity
- ✓ All customized length is available upon request

# WATER COOLED JUMPER (Aid Cable)

- ✓ Available in 185mm<sup>2</sup>, 200mm<sup>2</sup>, and 250mm<sup>2</sup>
- ✓ Special joining method to improve the durability of the cable
- ✓ Special twist to balance the stress regardless of the welding direction
- ✓ Made-to-order at any length
- ✓ Unique 150mm<sup>2</sup> model comes with full-length filter tube to insure free-flow water path, also available

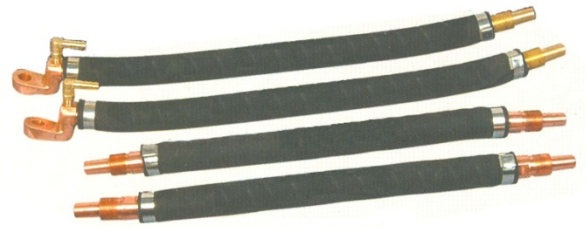

## Standard Terminal List

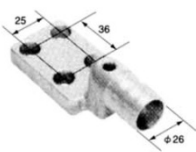

A-Type

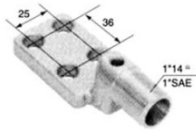

B-Type



C-Type

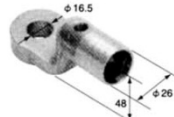

F-Type

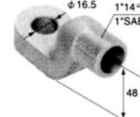

FB-Type



T-Type

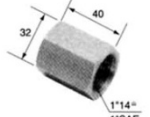

Nut

## AIR COOLED JUMPER

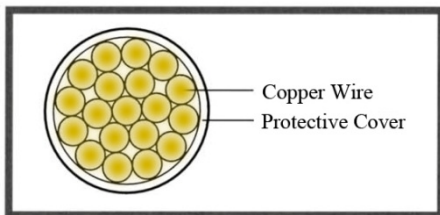

### CA-Type

- ✓ Cable twisted to form circular cross section
- ✓ Economical type for non-directional movement
- ✓ Available from 150mm<sup>2</sup> – 750mm<sup>2</sup>
- ✓ Made-to-order at any length
- ✓ Non-asbestos protective cover

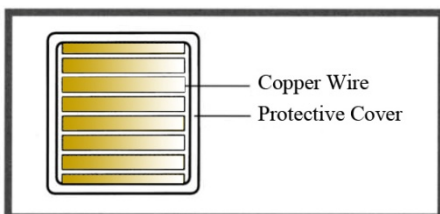

### SW-Type

- ✓ Cable laid in rectangular cross section
- ✓ Flat-braided tin-coated copper wire
- ✓ Advantage for unidirectional movement, increase flexibility and lifetime
- ✓ Available from 100mm<sup>2</sup> – 500mm<sup>2</sup>

## LAMINATED SHUNT

- ✓ Short delivery
- ✓ Made-to-order
- ✓ Available up width of 150mm
- ✓ High flexibility and conductivity copper material
- ✓ Improved pressed rivet method for better joint



### M.S. TRADING EU HUA GUANG JEAR SUNG CO., LTD.

346 On-Nuch Road, Praves, Bangkok 10250, Thailand

Tel: +66 2 328 7456 / Fax: +66 2 328 7431

Email: [info@ms-cable.com](mailto:info@ms-cable.com) / Website: [www.ms-cable.com](http://www.ms-cable.com)

